

RANGER 53 PRO

CODE 396A

OWNER'S HANDBOOK

English Version
FROM SERIAL NO: 396A001001
ISSUE 10.04.02

HANDBOOK: 396007 (REV.0.)

EC DECLARATION OF CONFORMITY

SANDRIGARDEN
via Manzoni 22
36027 Rosa, Italia.



Declare that the lawnmower:

Models:	Ranger 53 Pro
Machine Type No.	CODE 396A (SG56 RC VAR PROF)
Category:	Auto Drive/Variable Speed
Type:	Pedestrian Rotary
Engine - Manufacturer:	Briggs & Stratton
- Speed of rotation:	2900rpm
Width of cutting device:	520mm
Speed of rotation of the cutting device:	2900rpm

Complies with the provisions of Directive: 98/37/EC Essential Health & Safety Requirements Relating to the Design & Construction of Machinery and Safety Components.

Also Directive 89/336/EEC amended by 92/31/EEC Electromagnetic Compatibility.

Also Directive 2000/14/EC Noise emission in the environment by equipment for use outdoors. (ANNEX VI)
Notified Body: NOVICOM SAS DI R. CASTELLI & CO. Via della Fontana 23804 Monte Marenzo (LC)
Notified body identification No: 0723

Measured sound power level:	98 dB(A)
Guaranteed sound power level:	100 dB(A)

Standards Used: EN292, EN836 and ENISO14982.

Authorised Signatory:

Signed

Direttore Generale
Alberto Cattaneo

Date: 10.04.02

Technical documentation kept at:
SANDRIGARDEN,
via Manzoni 22,
36027 Rosa, Italia.

VIBRATION INFORMATION

Lawnmower vibration information. RMS acceleration measured in 3 - axes at operators contact position on the handlebars. **CODE 396A (SG56 RC VAR PROF) = 12 ms⁻²..**

CONTENTS	Page No.
INTRODUCTION.	1.2
WARRANTY.	1.3
SAFETY PRECAUTIONS.	1.4 - 1.7
Decals	1.7
SPECIFICATIONS.	1.8
ASSEMBLY INSTRUCTIONS.	1.9
General assembly.	1.9
Assembling the mower for the first time.	1.10 - 1.12
STARTING THE ENGINE.	1.13
Before starting the engine.	1.13 - 1.14
Starting the engine.	1.15
STOPPING THE ENGINE.	1.16
OPERATING THE MOWER.	1.16
Height of Cut.	1.17
Travel.	1.18
Turning the mower.	1.18
Mowing with grass collection.	1.19
Mowing without grass collection.	1.20
Heavy growth.	1.20
Moving the mower across non-grassed areas	1.20
Cutterbar operation.	1.21
Mowing and grass care tips.	1.21 - 1.22
MAINTENANCE.	1.23
Engine.	1.23
Grassbag.	1.23
Deck housing.	1.23
Securing nuts and bolts.	1.24
Lubrication.	1.24
Clutch cable adjustment.	1.24
Cutterbar.	1.25 - 1.26
Maintenance Schedule.	1.27 - 1.28
PREPARING THE MOWER FOR STORAGE.	1.29
FAULT FINDING.	1.30 - 1.31
396 PARTS LIST.	2.1 - 2.4
396 PARTS DIAGRAM.	2.5
ENGINE ANCILLARY PARTS	2.6
NOTES.	2.7
CUSTOMER INFORMATION.	2.8

INTRODUCTION

Thank you for purchasing a **Hayter** mower. The following pages are designed to help you gain safe and efficient service from your machine.

IMPORTANT: This Owners Handbook should be regarded as part of the machine as it gives essential information regarding machine safety, operation, maintenance and specifications. Read and understand this handbook prior to operating your machine for the first time. Make sure you are familiar with all the controls and points of regular maintenance. If you have any doubts, consult your **Hayter** authorised dealer who will be pleased to give you assistance.

The mower is designed solely for use in a domestic grass cutting environment. Use in any other way is considered as contrary to the intended use. Compliance with and strict adherence to the conditions of operation, service and repair as specified in this handbook also constitute essential elements of the intended use.

This mower should be operated, serviced and repaired only by persons who are familiar with its particular characteristics and who are acquainted with the relevant safety procedures. The safety precautions listed herein and all other generally recognised regulations on safety must be observed at all times.

All **Hayter** mowers are robustly constructed and designed for efficient economical performance under normal mowing conditions. Correct operation and maintenance will ensure a long and satisfactory service life. Prior to despatch from our factory every effort is made to ensure your machine arrives in perfect condition. Your dealer will carry out a pre-delivery inspection to ensure that there has been no transit damage prior to installation. **Please allow your dealer to familiarise you with the controls and safety features of the machine during installation.**

Throughout this handbook all references to left hand and right hand are as viewed from behind the handlebar, facing in the direction of forward travel.

This owners handbook is based on information available at the time of publication. **HAYTER LIMITED** reserve the right to make changes at any time without notice.

LIMITED WARRANTY

Hayter Limited warrants to the original user/purchaser that this unit shall be free from defects in material and workmanship under normal use and service for a period of one year from the date of purchase. The manufacturers of the engine furnish their own warranty and services are provided through their authorised network (Refer to "Engine Warranty Statement"). To qualify for the full benefit of the warranty, the warranty registration card must be returned within 60 days of purchase. Subject to the conditions and exclusions noted in this limited warranty, we shall at our option, repair or replace any warranted part during the applicable period. If you are in doubt or experience any difficulty, please consult a Hayter Authorised Service Dealer for clarification.

A 90 day warranty period applies to those items which are subject to normal wear and tear e.g. wheels, cutterbars, cables, grassbags and other consumable wearing parts.

All machines which are fitted with a genuine Hayter friction disc or crankshaft support bearing as original equipment before use, are covered by a Lifetime Warranty against the engine crankshaft bending. Note: friction washers, blade brake units and other such devices are not applicable. Only machines fitted with a genuine Hayter friction disc or crankshaft support bearing, which are used in accordance with the recommended operating and maintenance procedures, are covered.

This warranty does not apply to any unit that has been tampered with, altered, misused, abused or used for hire, and will become invalid if non genuine Hayter parts are fitted. This warranty does not cover for minor mechanical adjustments unless they are due to defective material or workmanship. Consult the Owner's Handbook or a Hayter Authorised Service Dealer for assistance when making these adjustments.

To make a warranty claim, return the unit to a Hayter Authorised Service Dealer along with proof of purchase stating the machine serial number and date of purchase. Subject to the conditions and exclusions in this limited warranty, the authorised dealer will, at our option, repair or replace any warranted part within the duration of the warranty period.

This limited warranty gives you specific legal rights and is in addition to any statutory rights to which you may be entitled and your statutory rights are not affected by this warranty. If you need additional information concerning this written warranty, or assistance in obtaining services, please write to : HAYTER LIMITED, Service Department, Spellbrook, Bishop's Stortford, Hertfordshire CM23 4BU

UK ONLY: Details of your local Hayter authorised dealer are contained in Yellow Pages or contact:- Freephone 0800 616298.

SAFETY PRECAUTIONS



THIS SYMBOL MEANS BE ALERT! YOUR SAFETY IS INVOLVED. WHEN YOU SEE THIS SYMBOL BE ALERT TO THE POSSIBILITY OF INJURY. CAREFULLY READ THE MESSAGE THAT FOLLOWS AND INFORM OTHERS. EXERCISE GREAT CARE AND FOLLOW THE ADVICE GIVEN TO AVOID POTENTIALLY HAZARDOUS SITUATIONS.

The Ranger 53 Pro is perfectly safe if used correctly. Failure to observe the following simple precautions may result in serious injury.

Training:

Read the instructions carefully. Ensure that you are familiar with the controls and the proper use of the equipment. Learn how to stop the mower quickly in an emergency.



Never allow children or people unfamiliar with these instructions to use the mower.



Never mow while people, especially children, or pets are nearby.



Keep in mind that the user is responsible for accidents or hazards occurring to other people or their property.

Preparation:

While mowing, always wear substantial footwear and long trousers. Do not operate the equipment when barefoot or wearing sandals.



Thoroughly inspect the area where the mower is to be used and remove all objects which may be thrown by the machine.



WARNING: Petrol is highly flammable.

-Store fuel in containers specifically designed for this purpose.

-Refuel outdoors only and do not smoke while refuelling.

-Add fuel before starting the engine. Never remove the cap from the fuel tank or add petrol while the engine is running or when the engine is hot. Allow engine to cool for at least 2 minutes before refuelling.

-Do not attempt to start the engine if petrol is spilled or a smell of petrol is present but move the mower away from the area of spillage and avoid creating any source of ignition until petrol vapours have dissipated.

- Always use fresh fuel. Stale fuel can block the carburettor and cause leakage.

SAFETY PRECAUTIONS**Continued.**

- Replace all fuel tank caps and fuel container caps securely.

- Replace faulty exhaust and mufflers.



Always ensure that the mower is in a safe operating condition. Frequently check all nuts, bolts and screws for tightness. Use only genuine **Hayter** replacement parts.



Damaged cutterbars and loose fixing bolts are major hazards. Before use, visually inspect the cutting mechanism to ensure that it is in good condition. A damaged cutterbar must be replaced immediately with a genuine **Hayter** replacement part. Cutterbars which are slightly worn can be resharpened. Ensure that both cutting edges are resharpened equally to maintain balance. An unbalanced cutterbar may cause serious damage to your machine. Refer to "Maintenance."

Operation:

Do not operate the engine in a confined space where dangerous carbon monoxide fumes can collect.



Mow only in daylight or good artificial light.



Avoid using the mower on wet grass, where feasible.



Always be sure of your footing on slopes.



Walk, never run.



Mow across the face of slopes, never up and down.



Exercise extreme caution when changing direction on slopes.



Do not mow excessively steep slopes.



Use extreme caution when reversing or pulling the mower towards you.



Stop the engine if the mower has to be tilted for transportation when crossing surfaces other than grass and when transporting the mower to and from the area to be mowed.



Never operate the mower unless the guards are securely in position and in good condition.



Do not change the engine governor settings or overspeed the engine.



Disengage the drive clutch before starting the engine.

SAFETY PRECAUTIONS**Continued.****Operation continued:**

Start the engine carefully, with feet well away from the cutterbar.



Do not tilt the mower when starting the engine.



Do not put hands or feet near or under rotating parts.



Never pick up or carry a mower while the engine is running.



Stop the engine and disconnect the spark plug lead:

- Before clearing blockages or unclogging the discharge chute.

- Before cleaning/checking or working on the mower.



Stop the engine:

- Whenever you leave the mower.

- Before refuelling.

- After striking a foreign object. Inspect the mower for damage and make repairs before restarting and operating the mower.

- If the mower starts to vibrate abnormally (check immediately).



Do not lift the rear deflector whilst the mower is in operation.









WARNING: THE CUTTERBAR CAN CONTINUE TO ROTATE AFTER THE ENGINE IS SWITCHED OFF.

SAFETY PRECAUTIONS

Continued.

Maintenance and storage:

-  Keep all nuts, bolts and screws tight to ensure that the equipment is in safe operating condition.
-  Never store the mower with petrol in the tank within an enclosed area where fumes may reach an open flame or spark.
-  Allow the engine to cool before storing in any enclosure.
-  To reduce the fire hazard, keep the engine, silencer, and petrol storage area free of grass, leaves, or excessive grease.
-  Check the grassbag frequently for wear or deterioration.
-  Replace worn or damaged parts for safety. Use genuine Hayter parts only.
-  If the fuel tank has to be drained, it is essential that this be done outdoors.

DECALS

WARNING DECAL:

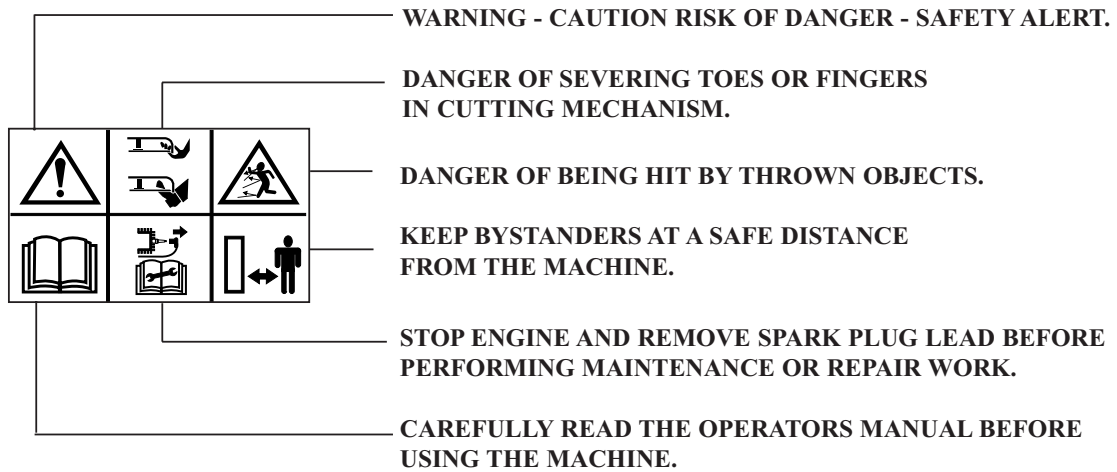

**DECAL :
HEIGHT OF CUT ADJUSTMENT**

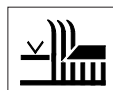

**DECAL:
ENGINE STOP**



DECAL: GROUND SPEED

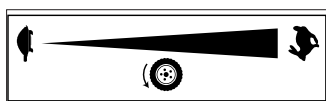

DECAL: THROTTLE CONTROL

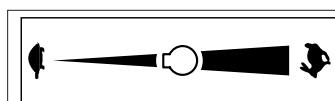

SPECIFICATIONS

MODELS	CODE 396(SG56 RC VAR PROF)
Engine	Briggs & Stratton Intek Edge 60
Engine type	121602-0166-E1
Engine / cutterbar speed	2900 rpm
Fuel type	Unleaded petrol.
Fuel capacity	1.5 litres
Oil type	SAE 30 engine oil
Oil sump capacity	0.6 litres
Cutting width	530mm
Cutting height	25 - 100mm
Overall dimensions	1700 x 600 x 1130mm
Dry Weight	57.5 Kg

ASSEMBLY INSTRUCTIONS

SAFETY NOTICE



Before using the mower, read this owners handbook carefully.
Pay particular attention to the safety precautions.

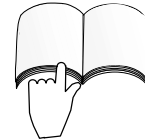

GENERAL ASSEMBLY

1. Spark Plug Lead.
2. Primer Bulb.
3. Engine Cover.
4. Air Filter.
5. Fuel Filler Cap.
6. Oil Filler Cap & Dipstick.
7. Height of Cut Lever.
8. Rear Deflector.
9. Handlebar Securing Knob
10. Engine Start Grip.
11. Throttle Control.
12. Lever - Engine Stop.
13. Handlebar.
14. Ground Drive Clutch Lever.
15. Ground Drive Speed Control.
16. Grassbag Assembly.
17. Serial No. Label.
18. Muffler Guard.

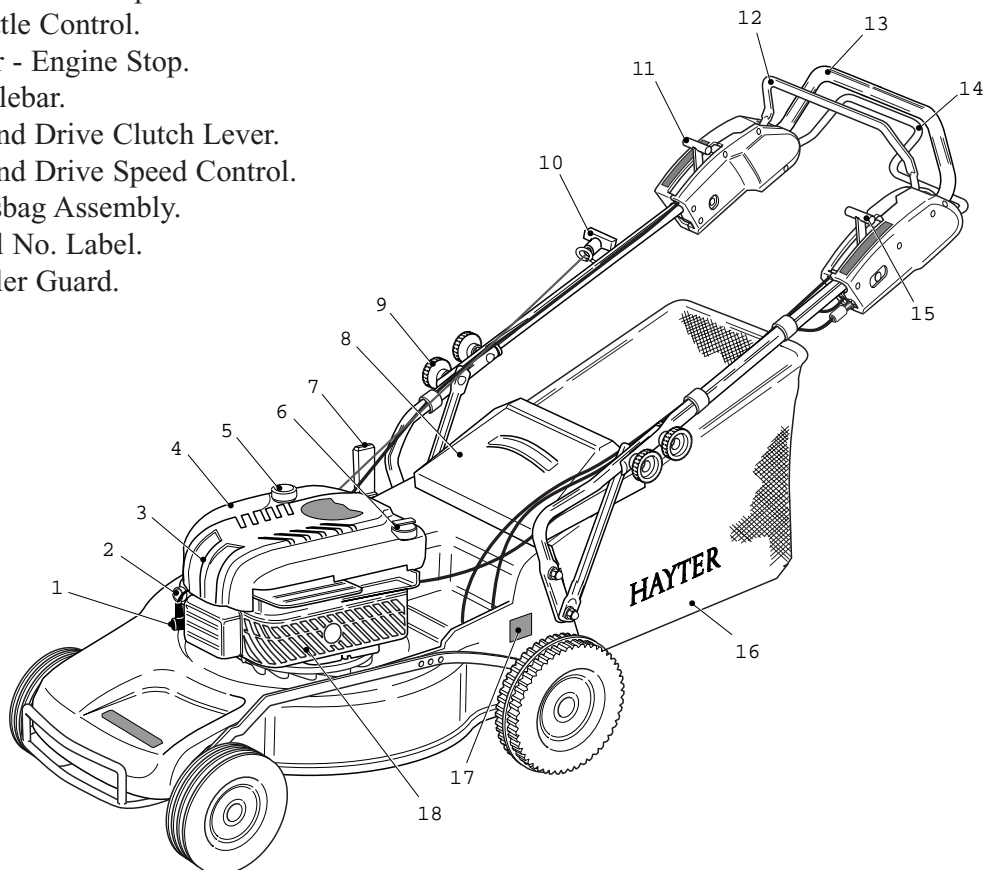

ASSEMBLING THE MOWER FOR THE FIRST TIME

Check that parts are delivered correctly: Remove the mower from the packaging and check that all loose items have been supplied correctly. Refer to the delivery checklist opposite and the general assembly. If any items are missing, contact your local authorised Hayter Dealer.

DELIVERY CHECKLIST

Description	Quantity
Handlebar Lower LH	1
Handlebar Lower RH	1
Coach Bolt	4
Washer	4
Nut	4
Handlebar Support LH	1
Handlebar Support RH	1
Large Knob	4
Upper Handlebar	1
Cap	4
Cable Guide	4
Grassbag Frame	1
Grassbag Fabric	1
Grassbag Flap	1
Owner's Handbook	1
Engine Handbook	1
Warranty Reg. Card	1

Assemble the handlebars: Assemble the handlebars as shown. Route the cables carefully and clip in position to avoid damage and entanglement when using the machine.

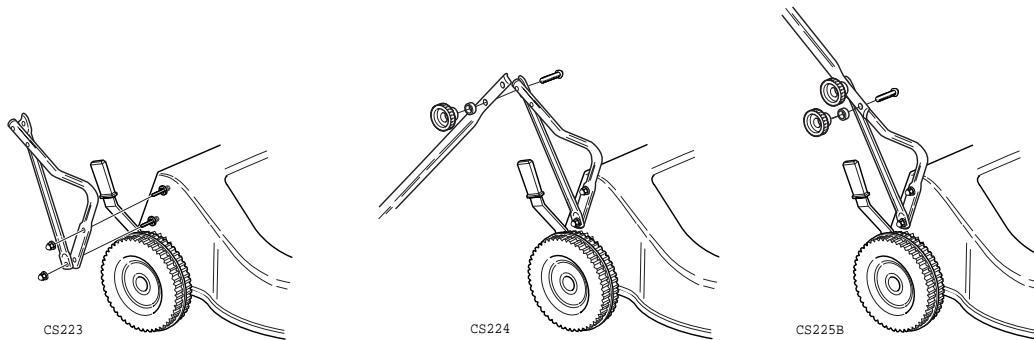

CAUTION - PREVENT DAMAGE : When assembling the handlebar, take care to ensure that the controls and cables do not become damaged. Always replace damaged controls and cables before using the mower.

ASSEMBLING THE MOWER FOR THE FIRST TIME
Continued.

Assemble the grassbag: Insert metal frame into grassbag fabric and clip into position. Push grassbag flap onto frame to fix in position.

WARNING - PREVENT ACCIDENTS: Always ensure grassbag flap is securely fitted and in good condition.

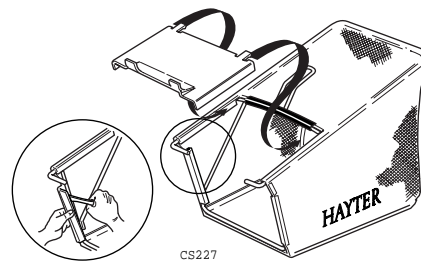
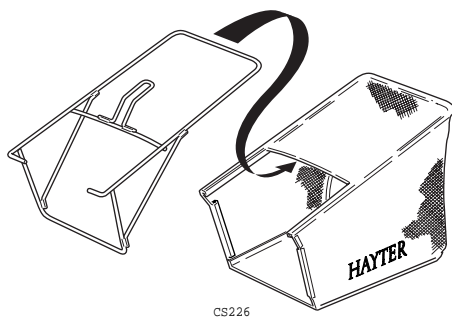

Raise the rear deflector and lower the grassbag through the handlebar aperture to connect onto the upper mounting points. Lower the grassbag to rest against the rear of the mower. Ensure the grassbag flap is closed. Finally lower the rear deflector to rest against the top of the grassbag

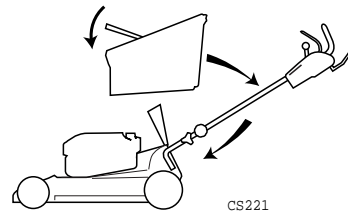

ASSEMBLING THE MOWER FOR THE FIRST TIME

Continued.

Check all fasteners are secure.



Check engine stop lever operation: Operate the engine stop lever several times. Ensure that the cable moves freely and that the lever returns automatically to the engine stop position when released.

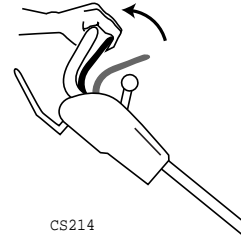

Check throttle lever operation: Operate the throttle lever several times and ensure the cable moves freely whilst operating the engine throttle mechanism.

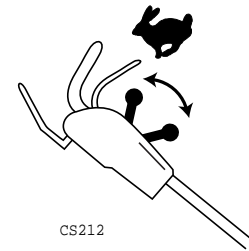

Check clutch lever operation: Operate the clutch lever several times and ensure that the cable moves freely.

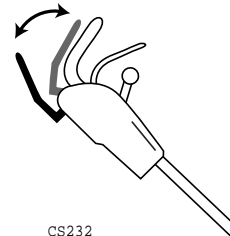

BEFORE STARTING THE ENGINE

IMPORTANT - PREVENT ENGINE DAMAGE: The engine is shipped without oil or petrol. The engine must be filled with the correct grade of oil and petrol before starting the engine.

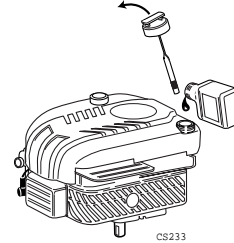

Oil recommendations: Always use high quality detergent oil classified "For service SE, SF, SG" SAE 30 oil. Never use additives with recommended oils.

SAE 10W-30 multigrade oil may be used, but this will result in higher engine operating temperatures with consequential high oil consumption. It is imperative that the oil level is checked more frequently if this grade of oil is used in order to guard against serious engine damage.

Check oil level: Clean around the oil filler cap before removing. With the mower on a level surface, unscrew and remove the oil filler-dipstick. Wipe oil from it with a clean cloth. Screw the oil filler-dipstick back in place, then unscrew and remove it to check the oil level.

The oil level is correct when it is at the **full** mark on the dipstick. **DO NOT OVERFILL.**

Slowly fill with engine oil as necessary and replace the oil filler-dipstick.

IMPORTANT: The oil filler-dipstick must be secured to prevent oil leakage during operation.

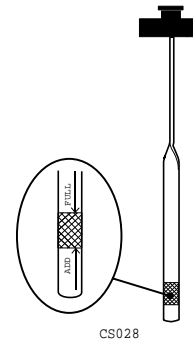

BEFORE STARTING THE ENGINE**Continued.**

Fuel recommendations: Always use clean, fresh unleaded petrol. Purchase fuel in quantities which can be used within 30 days. Never mix oil with petrol. For added engine protection Briggs & Stratton recommend the use of their fuel additive which is available from an authorised Briggs & Stratton service dealer.

Check fuel level: Clean around the fuel filler cap before removing and fill the fuel tank with clean unleaded petrol.

Do not overfill the fuel tank. Allow 6mm minimum of tank space for fuel expansion.

IMPORTANT: The fuel filler cap must be secured to prevent fuel leakage during operation.

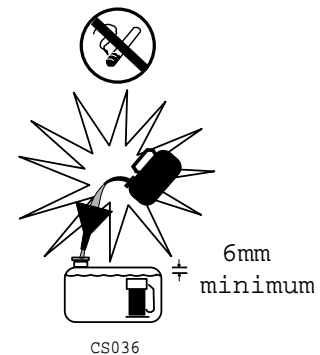

WARNING - PREVENT ACCIDENTS: The cutterbar rotates when the engine is operating.

ALWAYS operate the engine stop lever several times and ensure the engine stop cable moves freely before starting the engine.

ALWAYS position the mower on a level stone free grass surface before starting the engine. Ensure that the cutterbar is set above grass height to prevent the engine being started under load.

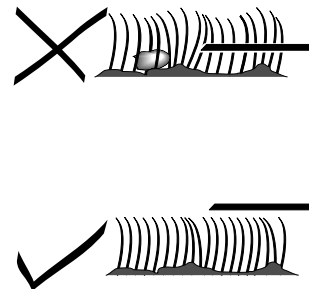

STARTING THE ENGINE

Operate the primer bulb: Push on the primer bulb 5 times at two second intervals to provide the extra fuel to start the engine after assembling the mower for the first time.

In normal use, push on the primer bulb 3 times at two second intervals to provide the extra fuel required to start a cold engine. Operation of the primer bulb is usually unnecessary when starting a warm engine.

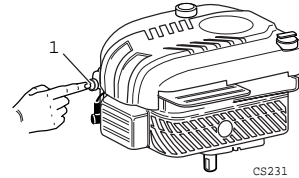

Operate the throttle control lever: Push the lever to the fast position.

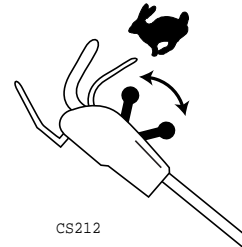

Operate the engine stop lever: Use one hand to hold the engine stop lever in the operating position firmly against the handlebar. To start and operate the engine the engine stop lever must be held in the operating position. If the engine stop lever is released the engine will stop.

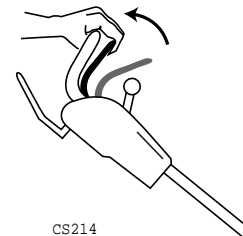

Operate the engine start - grip: Stand behind the mower and maintain a firm hold on the handlebar and the engine stop lever to prevent the mower moving towards you. Use your right hand to hold the engine start-grip and pull slowly until resistance is felt, then pull rapidly to crank the engine. When the engine starts carefully return the engine start-grip to the storage position. If the engine does not start after 5 attempts - refer to "Fault Finding".

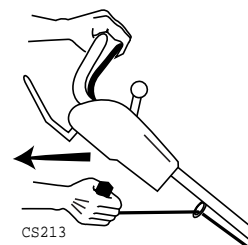

IMPORTANT: Prevent engine damage. Never pull the engine start-grip when the engine is running.

STOPPING THE ENGINE

Stopping the engine: Disengage the engine stop lever by releasing the engine stop lever.

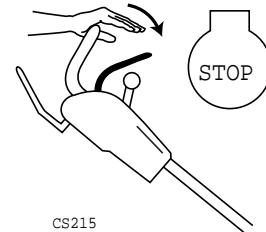

Emergency stop: If the engine stop lever fails, disconnect the spark plug lead to stop the engine.

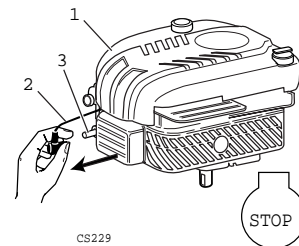

1. Engine
2. Spark Plug Lead
3. Spark Plug

OPERATING THE MOWER

SAFETY NOTICE



WARNING - PREVENT ACCIDENTAL STARTING :
Always stop the engine and disconnect the spark plug lead before cleaning, inspecting or working on the machine.

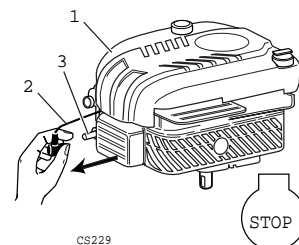

1. Engine
2. Spark Plug Lead
3. Spark Plug

SAFETY NOTICE Continued

WARNING: PREVENT ACCIDENTS Before mowing, thoroughly inspect the area where the mower is to be used and remove all stones, sticks, wires, bones and other foreign objects, which when contacted by the mower cutterbar could become dangerous projectiles. Inspect the area for hidden obstructions which when contacted by the cutterbar could risk health and safety. Remember the location of these obstructions and ensure that you mow around them.

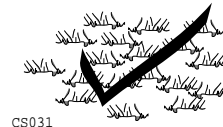
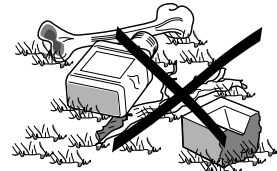

CS031

CAUTION: Prevent engine damage - DO NOT use the mower on a slope greater than 20 degrees.

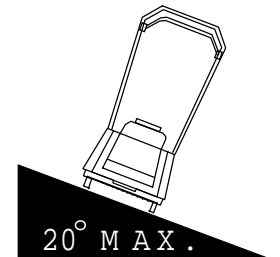

CS080

HEIGHT OF CUT

To adjust the height of cut : Grip the lever and pull sideways to disengage it from the locking notch, then push forwards to raise or pull backwards to lower the height of cut. Finally release the lever at the required position and ensure it locks firmly into one of the eight setting notches.

Always select a height of cut to suit operating conditions. Aim to prevent engine overloading and blockages by avoiding low cuts in long grass conditions. Be prepared to make two cuts when the grass is long.

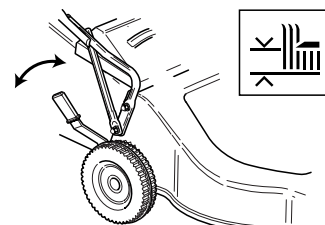

CS219

TRAVEL

Forward Travel: Hold the handlebar and operate the clutch lever to power the mower in a forward direction.

Release the clutch lever to stop the mower from travelling in a forward direction

Speed Control:

Travel speed can be altered by selecting a different position on the ground drive speed control lever. With the engine running and the clutch lever engaged push the lever forward to reduce speed and pull backwards to increase.

When the clutch lever is disengaged the mower can be operated as a push model. This feature is useful when mowing in confined areas.

Note: The engine stop lever must be held firmly against the handlebar to keep the engine running.

Reverse Travel: Release the clutch lever. Hold and pull against the handlebar with both hands to reverse the mower towards you.

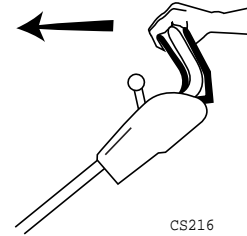

CS216

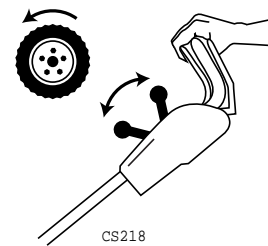

CS218

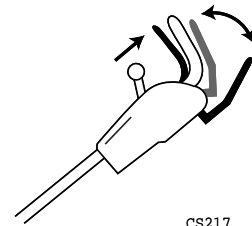

CS217



WARNING - PREVENT ACCIDENTS : Always reverse the mower carefully towards you. Always switch off the engine before walking backwards with the mower.

TURNING THE MOWER

To make a wide turn : Steer the mower with the handlebar whilst travelling forward.

To make a tight turn : Stop forward travel. Apply downward pressure on the handlebar to raise the front wheels of the mower just above ground level and steer the mower using the handlebar in the required direction.



WARNING - PREVENT ACCIDENTS : DO NOT raise the front of the mower excessively when making a turn. NEVER raise the rear of the mower when the engine is running.

MOWING WITH GRASS COLLECTION

The grassbag is designed to collect grass clippings.

To achieve best grass collection performance, mow in dry operating conditions.

Recognise that when the grassbag is full the airflow stops and the grassbag deflates.



WARNING - PREVENT ACCIDENTS : ALWAYS check the condition of the grassbag for signs of damage. Replace a damaged grassbag immediately. **DO NOT** operate the mower with a damaged grassbag. ALWAYS stop the engine and disconnect the spark plug lead before attempting to remove a grass

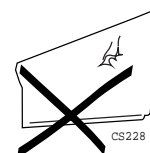

Grassbag attachment: Raise the rear deflector and lower the grassbag through the handlebar aperture to connect onto the upper mounting points. Lower the grassbag to rest against the rear of the mower. Ensure grassbag flap is closed. Finally lower the rear deflector to rest against the top of the grassbag.

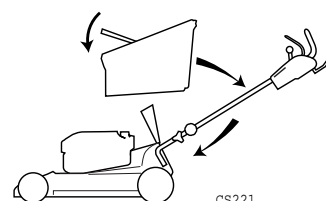

Grassbag removal: Raise the rear deflector and lift the grassbag through the handlebar aperture and away from the mower. Finally lower the rear deflector to rest against the rear of the mower.

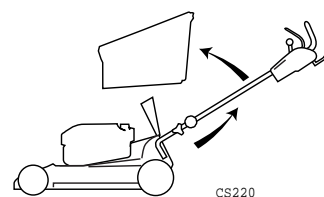

Grassbag emptying: To empty the grassbag, pour out the grass clippings and shake the grassbag vigorously to clean the airways. Good grass collection depends on good air flow through the grassbag. When collecting grass clippings it is important that the grassbag is emptied regularly to prevent blockages and engine overloading.

MOWING WITHOUT GRASS COLLECTION

To mow without collecting the grass clippings, remove the grassbag and operate the mower with the rear deflector in its lowest position.

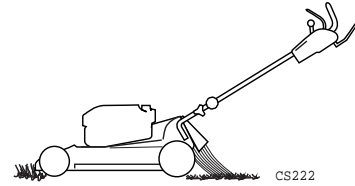

WARNING - PREVENT ACCIDENTS : ALWAYS check the condition of the rear deflector for signs of damage. Replace a damaged rear deflector immediately. Never operate the mower with a damaged rear deflector.

HEAVY GROWTH

Areas of heavy growth should be mown without grass collection. If grass collection is required first mow the area without grass collection at the maximum height of cut setting. Allow the grass clippings to dry out and then mow the area at the maximum height of cut setting with the grassbag fitted. Reduce the height of cut and mow the area again as necessary until the required finish is obtained.

MOVING THE MOWER ACROSS NON-GRASSED AREAS

Set the mower to its maximum height of cut to protect the cutting mechanism when transporting the mower over surfaces other than grass.



WARNING - PREVENT ACCIDENTS : Always stop the engine and push the mower carefully at slow walking speeds.

CUTTERBAR OPERATION

The cutterbar rotates at the same speed as the engine. The cutterbar will stop within three seconds of the engine being switched off.



WARNING - PREVENT ACCIDENTS : DO NOT operate the mower if the cutterbar fails to stop within three seconds. Return the mower to your Hayter dealer for examination and repair.

The cutterbar is driven by the engine via a friction device to help prevent damage occurring to the cutting mechanism when a hidden obstruction or overload is encountered. When the obstruction or overload situation is removed the friction device will automatically reset.



WARNING - PREVENT ACCIDENTS : ALWAYS stop the engine when a hidden obstruction or excessive vibration is encountered. Disconnect the spark plug lead and examine the cutting mechanism. ALWAYS replace a damaged cutterbar - refer to "Maintenance".

MOWING AND GRASS CARE TIPS

In dry weather conditions leave the grass long to help retain ground moisture.

Aerate the lawn to stimulate soil organisms and root growth. In spring and late summer remove dead grass and aerate the lawn by raking or similar means.

Maintain a sharp cutterbar. A blunt cutterbar will tear the grass and cause the tips to turn brown.

MOWING AND GRASS CARE TIPS**Continued.**

Prevent scalping. Plan your direction of travel to mow across hollows and humps.

Prevent grass damage. Take care when turning the mower.

Prevent grass damage. **DO NOT** mow in wet conditions.

Brush the lawn surface to disperse worm casts before mowing.

Spike compacted lawn areas with a fork. Fill the holes with sand to improve aeration and drainage.

Mow lawns in a different direction to the previous cut.

As a general rule the grass clippings should be removed each time you mow. If weather conditions are dry and hot and the grass is weed free, leave the clippings on the lawn to help maintain ground moisture.

Mow lawns twice a week when the grass is growing vigorously in the summer.

Mow lawns once a week in spring, autumn and during prolonged dry weather in the summer.

Prevent grass damage - DO NOT remove more than one third of the grass height in one cut.

Recommended grass heights for lawns:-

DANGER Coarse grasses dominate fine grasses. _____ **38mm**

General lawn in spring, autumn or prolonged dry period. _____ **32mm**

General lawn in summer. _____ **25mm**

Luxury lawn in spring, autumn or prolonged dry period. _____ **19mm**

Luxury lawn in summer. _____ **12mm**

DANGER Grass strength is reduced. _____ **6mm**

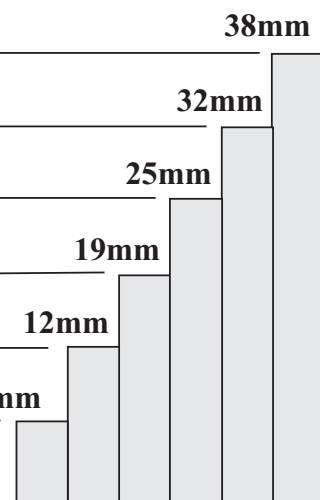

MAINTENANCE

ENGINE

Engine handbook: For details of engine maintenance refer to the engine operating and maintenance instructions handbook supplied with your mower.

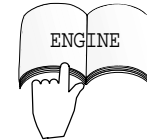

WARNING - PREVENT ACCIDENTS : ALWAYS stop the engine and disconnect the spark plug lead before attempting to carry out maintenance procedures on the mower.

IMPORTANT - Draining engine oil: To drain the engine oil, first drain fuel by operating the engine until the fuel tank is empty and the engine stops. Remove the spark plug lead and allow the engine to cool. Position the mower on its left hand side and ensure that the air cleaner side of the engine is kept uppermost. Remove the oil filler-dipstick to drain the oil.

GRASSBAG

Remove grass debris from the grassbag immediately after use and check its condition for signs of damage.

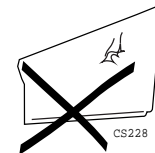

WARNING - PREVENT ACCIDENTS : Do not use the grassbag if damaged.

DECK HOUSING

Remove grass debris from the deck housing and around the engine immediately after use.

IMPORTANT - PREVENT DAMAGE: Fertilisers and top dressings are particularly corrosive. Thoroughly clean the mower deck immediately after use on treated grass and store well away from corrosive materials.

SECURING NUTS AND BOLTS

Regularly check that all securing nuts and bolts are tight.
Replace missing or damaged items immediately.

**LUBRICATION**

Lubricate the wheels, pivot points and linkages with engine oil every 25 operating hours.

Apply a good quality medium grease to the inner control cables at the point of entry and exit from their outer casings.

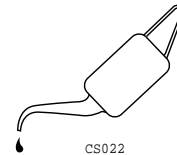
**CLUTCH CABLE ADJUSTMENT**

Check the clutch cable operation every 25 operating hours and adjust if necessary.

Unscrew locknut (1) and screw adjuster (2) in or out as necessary. Tighten locknut when correctly adjusted.

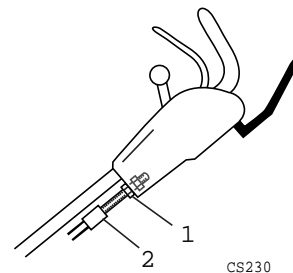

IMPORTANT - PREVENT DAMAGE: ALWAYS operate the mower with the clutch cable correctly adjusted. ALWAYS replace damaged cables.

CUTTERBAR



WARNING - PREVENT ACCIDENTS : Never work on the cutterbar unless the spark plug lead has been removed. The cutterbar has sharp edges. **ALWAYS** wear strong gloves to protect your hands when working on the cutterbar. **DO NOT** rotate tools towards the cutting edges to avoid the risk of injury should the tool slip. **ALWAYS** use genuine Hayter replacement parts.

The condition of the cutterbar and its mounting arrangement should be checked regularly for signs of wear or damage. Ensure that the cutterbar is not bent or cracked.

A damaged cutterbar that is out of balance will vibrate excessively and may break. **DO NOT** use an unbalanced cutterbar.

Regularly check that the bolt securing the cutterbar is tightened to the specified torque of 40Nm.

Replace the cutterbar every season or sooner if excessively worn or damaged.

How to remove the cutterbar:

Drain the fuel by operating the engine until the fuel tank is empty and the engine stops. **Remove the spark plug lead** and allow the engine to cool. Turn the mower on its **left hand side** and ensure that the air cleaner side of the engine is uppermost.

Firmly grip the end of the cutterbar with the gloved hand and remove the bolt, spring washer, spacer, large washer and friction washer securing the cutterbar with a suitable Hexagon Key.

How to assemble the cutterbar:

Assemble the cutterbar with the turned up edges facing towards the engine. Secure the cutterbar using the original bolt (1), spring washer (2), Spacer (3), large washer (4) and friction washer (5) and tighten to a torque of 40Nm.

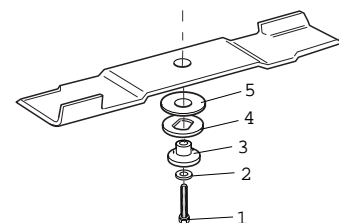

CS281

CUTTERBAR**Continued.**

How to sharpen and balance the cutterbar: A slightly worn cutterbar may be re-sharpened. All cutting edges must be sharpened equally to ensure balance. Sharpen the cutterbar every 25 mowing hours or more frequently if conditions require.

Remove the cutterbar from the mower and clean using a brush and water. Inspect the cutterbar for signs of damage.

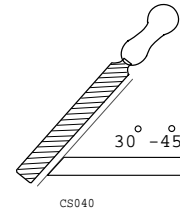

DO NOT use a damaged or excessively worn cutterbar.

Sharpen all the cutting edges with a flat file to restore the original cutting edge.

Ensure that the cutterbar is balanced. Use a screw driver with a round shaft to support the cutterbar through its centre hole. Hold the cutterbar horizontal and then release. A balanced cutterbar will remain horizontal. If the cutterbar is not balanced the heavy end will rotate downwards. Sharpen the heavy end until the cutterbar is correctly balanced.

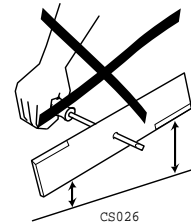
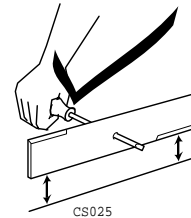

MAINTENANCE SCHEDULE

Follow the hourly or calendar intervals, whichever occurs first. More frequent service will be required if working for prolonged periods under dusty, dry conditions, or when airborne debris is present or after extensive operation cutting tall, dry grass.

AFTER FIRST 5 HOURS

- 1 *Change engine oil*

EVERY 5 HOURS OR DAILY

- 1 *Check oil level*
- 1 *Remove grass debris from around engine, muffler / muffler guard and air ways in the top cowl*
- 1 *Remove grass debris from top and underside of deck housing*
- 1 *Remove grass debris from the grassbag and check for signs of damage*
- 1 *Check condition of guards and safety devices*
- 1 *Check condition of cutterbar*

EVERY 25 HOURS OR EVERY SEASON

- 1 *Change engine oil if continuously operating under heavy load or high ambient temperature*
- 1 *Lubricate wheels, pivot points and linkages*
- 1 *Grease inner control cables at point of entry and exit from their outer casings*
- 1 *Check clutch cable adjustment*
- 1 *Sharpen cutterbar*

MAINTENANCE SCHEDULE Continued.**EVERY 50 HOURS OR EVERY SEASON**

- 1 *Change engine oil.*

EVERY 100 HOURS OR EVERY SEASON

- 1 *Clean engine cooling system. Clean more often under dusty conditions or when air borne debris is present or after prolonged operation whilst cutting tall, dry grass.*
- 1 *Service the dual element air cleaner cartridge.*
- 1 *Replace spark plug.*

PREPARING THE MOWER FOR STORAGE

Storage for periods in excess of 30 days: Engines stored in excess of 30 days need to be protected with Briggs & Stratton fuel additive or drained of fuel to prevent gum from forming in the fuel system or on essential carburettor parts. To ensure your mower is maintained in good working order it is important that the following procedure is adopted. Refer to the Maintenance section as necessary.

Drain fuel from the engine by operating the engine until it stops.

Disconnect the spark plug lead. Change the engine oil.

Remove the engine spark plug and pour 15ml of engine oil into the engine cylinder and replace the spark plug. Do not exceed the stated volume of oil as engine damage may occur on re-starting. **Do not replace the spark plug lead.** Operate the engine stop lever and slowly pull the engine start - grip once to crank the engine. This will distribute the oil and help prevent engine corrosion.

Clean grass and debris from the engine cylinder, cylinder head cooling fins, under top cowl, and around and behind muffler/muffler guard.

Clean all other areas of the mower and ensure that the grassbag is clean.

Lubricate the mower.

Treat metal parts with a water repellent anti-corrosion product.

Lower the handlebar, if desired.

Rest the mower deck on wooden blocks to remove the mower from its wheels / roller.

Cover the mower with a protective sheet and store it in a dry, ventilated area.

FAULT FINDING

PROBLEM	POSSIBLE FAULT	REMEDY
Engine will not start.	Engine under load. Fuel starvation. Incorrect / contaminated fuel. Spark plug lead disconnected. Engine brake not released. Faulty spark plug.	Raise height of cut. Fill fuel tank. Drain fuel tank and fill with correct fuel. Connect spark plug lead. Operate engine stop lever. Clean and adjust gap or replace.
Engine runs rough.	Spark plug lead becoming disconnected in use. Faulty spark plug. Air cleaner element blocked. Incorrect / contaminated fuel.	Connect spark plug lead. Clean and adjust gap or replace. Replace air cleaner element. Drain fuel tank and fill with correct fuel.
Engine vibrates excessively.	Mounting bolts loose. Cutterbar bolt loose. Cutterbar out of balance.	Tighten bolts. Tighten bolt. Balance cutterbar.
Engine will not turn over Engine smokes Engine runs then stops	Engine stop lever released Incorrect oil level Obstruction under deck Excess oil level Air cleaner cartridge oil soaked or plugged Fuel starvation Fuel cap vent blocked	Operate engine stop lever Check oil level Remove obstruction Check oil level Service air cleaner Fill fuel tank Clean fuel cap vent

FAULT FINDING
Continued.

PROBLEM	POSSIBLE FAULT	REMEDY
Uneven cut.	Undulating ground contours. Cutterbar worn. Cutterbar out of balance. Wheels damaged.	Change direction of travel. Sharpen the cutterbar. Balance cutterbar. Inspect and replace as necessary.
Discharge chute blocks.	Grass is wet. Cut height too low. Grassbag full. No airflow through the grassbag.	Mow dry grass. Increase cut height. Empty grassbag. Clean the grassbag.
Mower is hard to push.	Height of cut too low. Wheels damaged.	Increase height of cut. Inspect and lubricate or replace as necessary.
Mower will not self propel.	Clutch out of adjustment. Drive belt damaged.	Adjust clutch lever. Replace drive belt.
Poor grass collection.	No airflow through the grassbag. Discharge chute blocked. Wet grass. Grassbag full.	Clean the grassbag. Remove blockage. Mow dry grass. Empty grassbag.

PARTS LIST

ITEM NO.	DESCRIPTION	PART NO.	QTY.
1	Belt - Variable Pulley to Gearbox	SA284930	1
2	Belt - Engine Crankshaft to Variable Pulley	SA284920	1
3	Pulley - Variable	SA362860	1
4	Washer - Plain	SA2014040	2
5	Bracket - Pivot	SA380200	1
6	Spacer - Rear Wheel	SA2011120	2
7	Nut - M8	SA1013910	1
8	Plate - Gearbox	SA395620	1
9	Circlip	SA142180	1
10	Bolt - Carriage	SA101810	1
11	Rod - Rear Deflector (see item 121)	—	
12	Washer - Locating	SA280480	1
13	Setscrew	SA165110	1
14	Clamp - Cable	SA347810	1
15	Cable - Variable Speed	SA2013540	1
16	Cover - Variable Pulley	SA480190	1
17	Spring - Rear Deflector (see item 121)	—	1
18	Bearing	SA203560	10
19	Decal - Height of Cut	320006	1
20	Gear - Rear Wheel	SA496770	2
21	Cover - Wheel	SA380570	2
22	Washer - Plain	SA150770	4
23	Deck	SA380390	1
24	Key	SA101370	1
25	Boss - Pulley	SA2010190	1
26	Washer - Bellville	SA2006400	2
27	Washer - Large	SA3006420	2
28	Screw - M12 x 20	SA1013980	2
29	Blade	SA280520	1
30	Spacer - Location	SA3006410	1
31	Washer - Spring	SA281100	1
32	Screw - Blade	SA281080	1
33	Setscrew - Hex. Hd.	SA152010	4
34	Rim - Wheel	SA396610	2
35	Serial No. Label	—	1
36	Decal - Engine	396002	1
37	Engine	121602-0166-E1	1
38	Nut - Full	SA1013920	4
39	Plate - Clamp	SA344110	2
40	Screw - Self Tapping	SA180980	12

PARTS LIST

Continued.

ITEM NO.	DESCRIPTION	PART NO.	
41	Axle - Front	SA3013160	1
42	Bush - Axle	SA480180	2
43	Washer - Plain	SA144370	1
44	Wheel - Rear	SA385160	2
45	Decal - Hayter	533005	1
46	Nut - Full Flanged	SA1017320	2
47	Knob - Large	SA2008490	4
48	Cap	SA340060	4
49	Nut	SA194020	4
50	Handlebar - Lower R.H.	SA380600	1
51	Nut - Full Flanged	SA194010	7
52	Mounting Ring - Engine	SA396640	1
53	Handlebar - Upper	SA380420	1
54	Bolt - Carriage	SA101740	4
55	Loop - Recoil Rope	SA295640	1
56	Support R.H. - Handlebar	SA380590	1
57	Screw - Hex Hd. - Self Tapping	SA172850	2
58	Washer - Plain	SA181690	2
59	Bolt	SA172960	1
60	Bolt	SA184540	1
61	Cap - Hub	SA380740	4
62	Bolt - Special	SA3012890	2
63	Washer - Fixing	SA145900	4
64	Handlebar - Lower L.H.	SA380290	1
65	Support L.H. - Handlebar	SA380300	1
66	Flap - Grassbag	SA480400	1
67	Spring - Compensating	SA280160	1
68	Screw	SA1015560	3
69	Rod - Connecting	SA3013850	1
70	Strip - Protection	SA380970	1
71	Screw - Self Tapping	SA1012790	8
72	Throw Plate	SA380470	1
73	Nut - Flanged	SA142260	2
74	Lever - Height of Cut	SA480140	1
75	Spring - Torsion	SA280450	1
76	Pin - Roll	SA180460	1
77	Key - Drive	SA203510	2
78	Circlip	SA144590	4
79	Collar	SA403510	2
80	Spacer - Plastic	SA403520	2

PARTS LIST

Continued.

ITEM NO.	DESCRIPTION	PART NO.	
81	Gear	SA242210	1
82	Washer - Plastic	SA403540	2
83	Washer - Plastic	SA250780	2
84	Axle - Rear	SA3013180	1
85	Plate - Clamp	SA280550	2
86	Cap Screw - Soc Hd. C'Sunk	SA186210	2
87	Damper - Rear Deflector	SA403190	2
88	Lever - Engine Stop	SA380560	1
89	Handle - Rear Deflector	SA406070	1
90	Lever	SA443670	2
91	Bolt	SA147780	2
92	Washer - Lever	SA480710	2
93	Washer - Plain	SA144480	2
94	Gear	SA242220	1
95	Spacer	SA284100	4
96	Pin - Pivot	SA180790	2
97	Screw	SA140310	6
98	Nut - Nyloc	SA140270	10
99	Plate - Blanking	SA380690	1
100	Cover	SA480660	1
101	Cover	SA480840	1
102	Screw - Self Tapping	SA185610	6
103	Screw - Self Tapping	SA185620	4
104	Cover	SA480820	1
105	Wheel - Front	SA3013950	2
106	Spacer - Ground Drive Cable	SA460260	1
107	Spring - Ground Drive Cable	SA262090	1
108	Cable - Ground Drive	SA2013880	1
109	Cable - Engine Stop	SA2011320	1
110	Cover	SA480640	1
111	Gearbox	SA280230	1
112	Spring - Tension	SA295930	1
113	Pin - Roll	SA280890	1
114	Pulley	SA284840	1
115	Screw - Self Tapping	SA184940	8
116	Bolt - Engine	SA145670	2
117	Bolt - Engine	SA145680	1
118	Frame - Grassbag	SA380380	1
119	Lever - Ground Drive	SA380430	1
120	Cable - Throttle	SA285900	1

PARTS LIST

Continued.

ITEM NO.	DESCRIPTION	PART NO.	QTY.
121	Deflector - Rear (includes items 11 & 17)	SA380830	1
122	Setscrew	SA142760	2
123	Washer - Plain	SA144750	2
124	Guide - Cable	SA446340	4
125	Plug	SA251950	2
126	Decal - Throttle	SA647870	1
127	Decal - Engine Stop	SA690740	1
128	Bush - Crankshaft Support	SA280820	1
129	Decal - Variable Speed	SA689190	1
130	Support - Crankshaft (Includes Item 128)	SA380810	1
131	Decal - Warning	219189	1
132	Shim	SA145250	4
133	Washer - Wavy	SA245240	2
134	Screw - Self Tapping	SA172850	9
135	Skirt - Steel	SA380910	1
136	Skirt - Side	SA380900	2
137	Fabric - Grassbag	SA289560	1
138	Bumper - Bar	SA3016080	1
139	Ring - Locating	SA396620	2
140	Screw - Self Tapping	SA184950	28
141	Spacer	SA285480	2
142	Screw	SA142450	2
143	Nut - Full	SA142000	1
144	Nut - Dome	SA106440	1
145	Rim - Wheel	SA380750	2
146	Screw - M6 x 20	SA1017230	2
147	Caps - Front Wheel (Not Illustrated)	SA3006310	2
148	Wheel - Assembly (Front) (Includes 18,38,61,105,145)	SA3013940	2

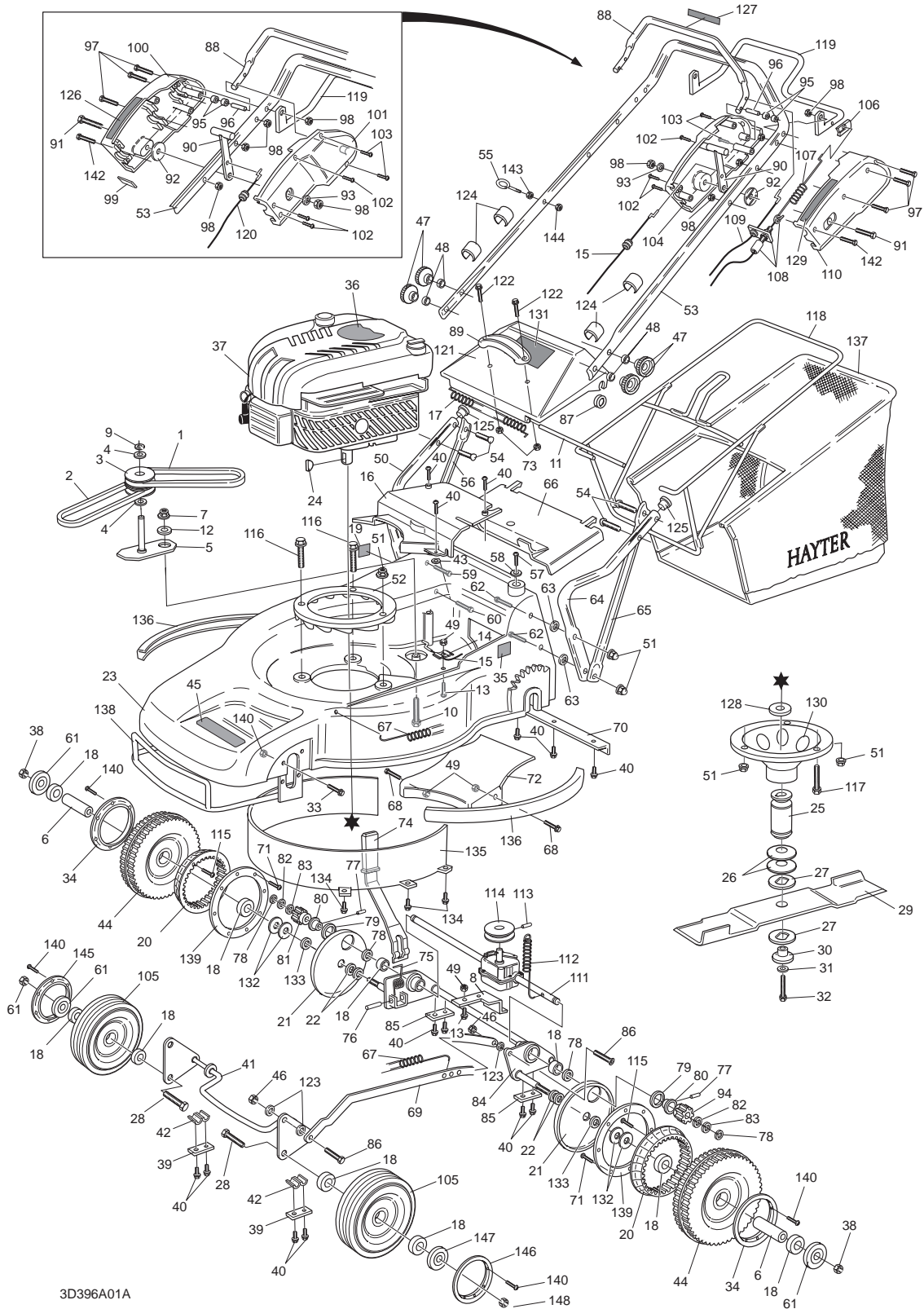

3D396A01A

These parts are available through an authorised Briggs & Stratton dealer.

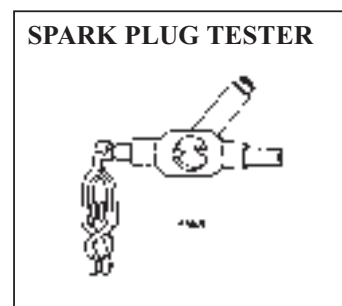
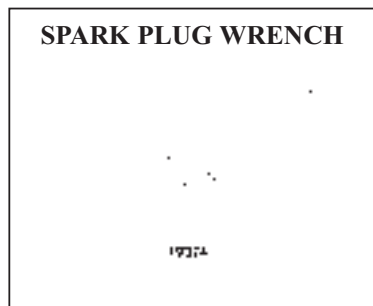
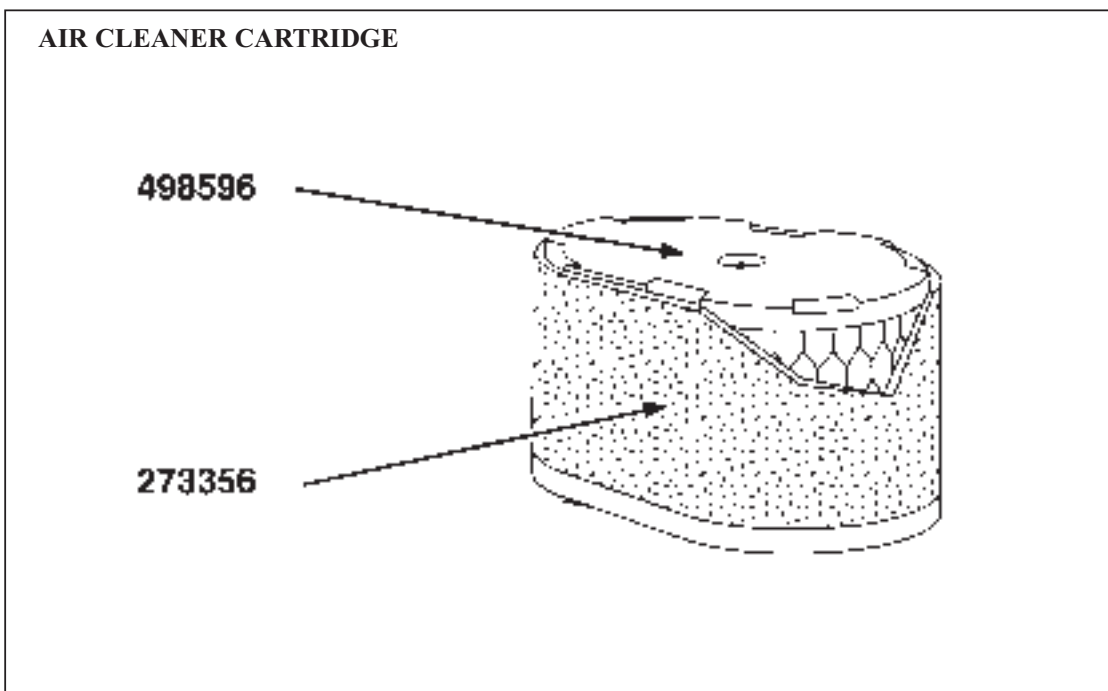
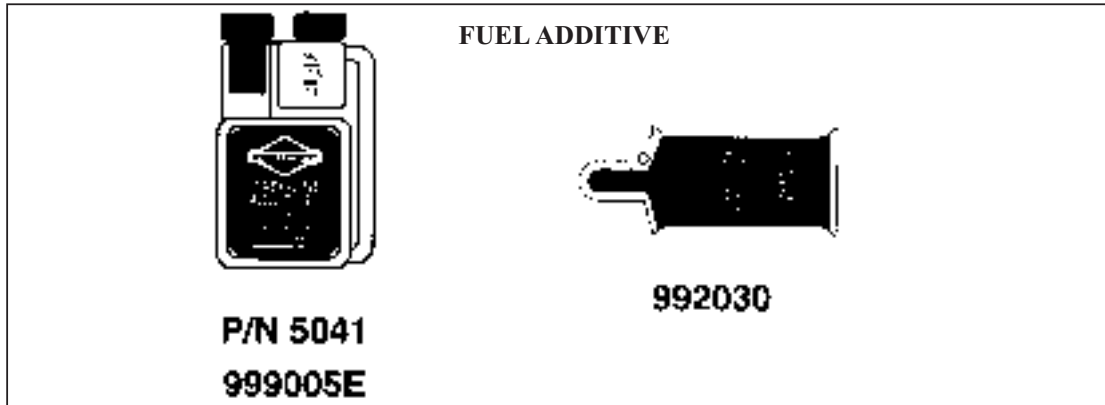

Machine Serial Number

Engine Serial Number

We hope you find the links below useful. For further gardening information visit
[Gardening Tools Direct](#)



Blower Vacs	Brush cutters	Brushcutters	Chainsaws	Chain saws
Cultivators	Cylinder lawn mowers	Cylinder mowers	Echo chainsaws	Echo Strimmers
Electric chainsaws	Fertiliser spreaders	Garden blowers	Garden rollers	Garden shredders
Garden tractors	Garden vacuums	Hayter lawn mowers	Hedge cutters	Hedgecutters
Hover mowers	Husqvarna chainsaws	Kawasaki brush cutters	Kawasaki strimmers	Lawn mowers
Lawn scarifiers	Lawn tractors	Leaf blowers	Leaf vacuums	Petrol chainsaws
Petrol hedge cutters	Ride on lawn mowers	Ride on mowers	Rotary mowers	Rotavators
Ryobi strimmers	Scarifiers	Strimmers	Westwood lawn tractors	Westwood ride on mowers
		Westwood tractors		